

Leveling Mount Units / Plates with Casters



Leveling Mounts Units

Part Number	Type	No.	Allowable Load kN (kgf)	Mass kg	Component					
					Plate	Leveling Mount	Screws	Quantity	Nut	Quantity
HAJPS	5	5	4.9 (500)	0.45	HAJP5	NFJN12-100	CBM5-10	4	HNTT5-5	4
		6			HAJP6		CBM6-12		HNTT6-6	
		8*			HAJP8		CBM8-20		HNTT8-8	
	6060	5050	16.6 (1700)	1.15	HAJPC5050	FJFN16-150	CBM6-15	8	HNTT6-6	8
		6060			HAJPC6060		CBM8-25		HNTT8-8	
		8080			HAJPC8080		CBM8-25		HNTT8-8	
9090	HAJPC9090	39.2 (4000)	2.9	HAJPC9090	FJFN20-150	CBM8-25	8	HNTT8-8	8	

① 8* is used in common with 8-45. ② Washers are included with HAJPS8080 only.
 ③ No. 6060, 8080 and 9090 are applicable to HFS6-6060, HFS8-8080 and HFS8-9090.

Plates with Casters



Plate with Casters (Casters with Stoppers)

Part Number	Type	No.	Allowable Load kN (kgf)	Mass kg	Component					
					Plate	Caster	Screws	Quantity	Nut	Quantity
HCHPS	5	5	0.9 (100)	0.69	HAJP5	HCHAS12-100	CBM5-10	4	HNTT5-5	4
		6			HAJP6	HCHAS12-150	CBM6-12		HNTT6-6	
		8*			HAJP8	HCHAS16-170	CBM8-20		HNTT8-8	

① 8* is used in common with 8-45.
 ② No.5 and 6 apply to extrusions with 6-slot width 20 Square Type and 8-slot width 30 Square Types.
 No.8 apply to extrusions 10-slot width 40 and 45 Square Type.

Leveling Mount Units & Plates with Caster Unit



Leveling Mounts + Plate with Caster Unit (Swivel Caster)

Part Number	Type	No.	Caster Allowable Load kN (kgf)	Leveling Mount Allowable Load kN(kgf)	Mass kg	Component								
						Plate	Leveling Mount	Caster			Extrusion Mounting			
						Body	Mounting Screw	Quantity	Mounting Screw	Quantity	Nut	Quantity		
HAJCHP	5	5	0.9 (100)	4.9 (500)	0.86	HAJPC5	NFJN12-100	HCHA12-100	—	—	CBM5-10	4	HNTT5-5	4
		2525				HAJPC2525	NFJN16-150	CHJF50S	CBM6-10	4	CBM5-15	8	HNTT6-6	8
		54040				HAJPC54040	NFJN12-100	HCHA12-150	—	—	CBM6-12	4	HNTT8-8	4
	6060	5050	16.6 (1700)	2.2	HAJPC8	FJFN16-150	CHJF50S	CBM6-12	4	CBM8-20	8	HNTT6-6	8	
		6060			HAJPC5050	FJFN16-150	CHJF50S	CBM6-10		CBM6-15		HNTT6-6		
		8080			HAJPC6060	FJFN20-150	CSHN-S50-N	CBM8-12		CBM8-25		HNTT8-8		
9090	HAJPC9090	2.9 (300)	39.2 (4000)	3.9	HAJPC9090	FJFN20-150	CSHN-S50-N	CBM8-12	CBM8-25	HNTT8-8	8			

① 8* is used in common with 8-45. ② Washers are included with HAJCH8080 only.



Mounting Example
Mounting of Leveling Mounts

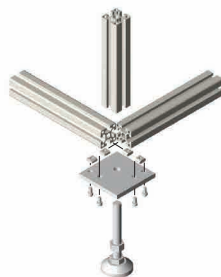

Mounting of Plate with Caster

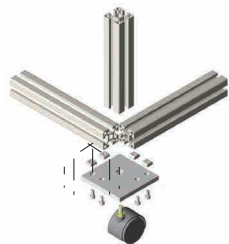

Mounting of the Leveling Mount + Plate with Caster

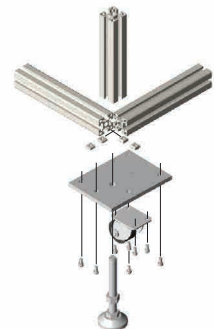

Mounting of HAJPD (Next Page)

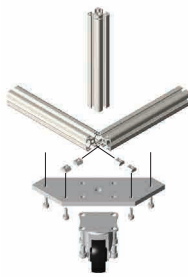

Plates

HAJP 5, 6, 8 HAJPSS 5, 6, 8

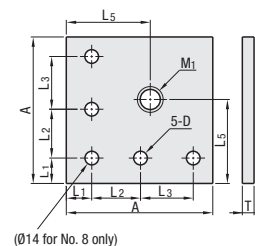

HAJPC 5, 6, 2525 HAJPCS 5, 6, 2525

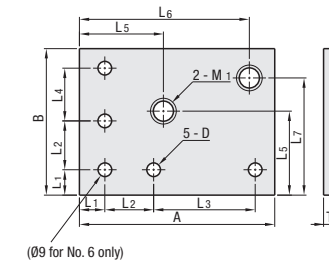

HAJPC 8 HAJPCS 8

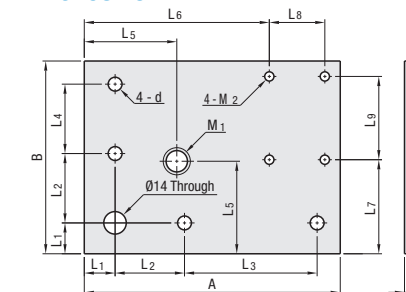

HAJPC 54040, 5050 HAJPCS 54040, 5050

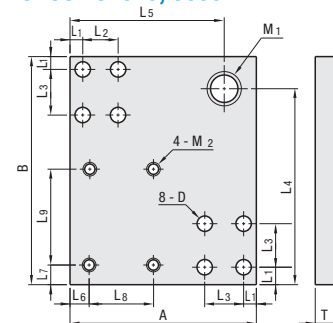

HAJPC 6060 HAJPCS 6060

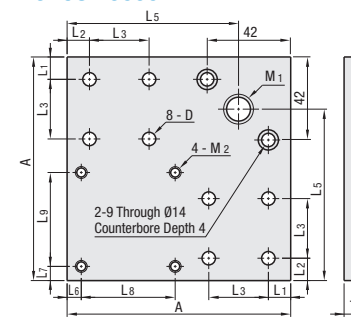

HAJPC 8080, 9090 HAJPCS 8080, 9090

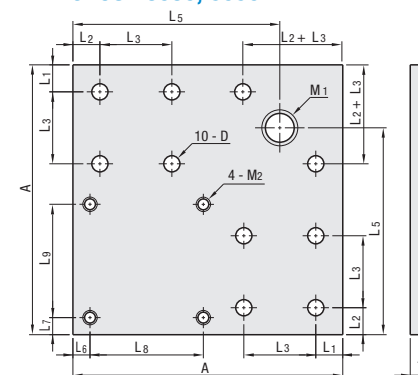

HAJPC 5, 6, 8 HAJPDS 5, 6, 8

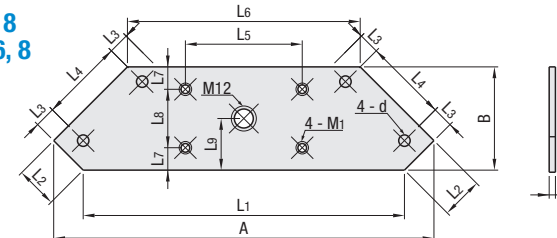

RoHS 10

Type	Material	Surface Treatment
HAJP, HAJPC, HAJPD	1018 Carbon Steel or Equivalent (Hot Rolled)	Trivalent Chromate
HAJPSS, HAJPCS, HAJPDS	304 Stainless Steel	—

Part Number	Type	No.	A	B	T	M ₁	M ₂	D	L ₁	L ₂	L ₃	L ₄	L ₅	L ₆	L ₇	L ₈	L ₉	Mass kg																
HAJP HAJPSS	5	5	75	—	6	12	—	5.5	8	30	27	—	43	—	—	—	—	—	0.24															
		6																		13	25	31												
		8*																		9	16	—	60	—	—	—								
HAJPC HAJPCS	5	5	135	75	6	12	—	5.5	8	30	87	27	43	122	60	—	—	—	0.45															
		2525																		10.5	—	—	—	—	—	—								
		54040																		8	20	20	107	82	11	10	36	54	0.82					
	6060	6	135	75	6	12	—	7	13	25	87	31	43	122	60	—	—	—	—	0.44														
		8*																			9	20	45	86	45	60	120	61	—					
		5050																			9	16	6	7	10	60	20	65	106	10	10	36	54	1.03
HAJPD HAJPDS	5	125	150	—	12	20	8	9	15	15	40	—	115	9.5	9.5	63	63	2																
		6060																	12	12	30	98	17	8	—	—	—							
		8080																	—	—	—	—	—	—	—	—	—	—	—	—	—	—	—	—
		9090																	165	—	—	—	—	—	—	—	—	—	—	—	—	—	—	—
HAJPD HAJPDS	6	5	184	50	6	6	—	5.5	154	20	10	40	56	112	11	28	25	0.53																
		6																	237	74	9	7	30	50	129	16	37	0.9						
		8																	250	82	12	8	9	193	40	20	55	144	20	42	41	2.1		

① 8* is used in common with 8-45.
 ② No. 6060, 8080 and 9090 are applicable to HFS6-6060, HFS8-8080 and HFS8-9090.
 ③ No. 5 and 6 apply to extrusions with 6-slot width 20 Square Type and 8-slot width 30 Square Types. No. 8 apply to extrusions 10-slot width 40 and 45 Square Type.
 ④ No. 5040 is applicable to the extrusion HFS5-4040.
 ⑤ No. 5050 is applicable to the extrusion HFS6-5050.

