

Guided Flat Belt Conveyors

Guided Belt to Prevent Lateral Movement, Center Drive, 3-Groove Frame (Pulley Dia. 50mm)

Features: The guided belt maintains straight movement. With the addition of tapped holes for pulley holders, mounting of optional parts becomes easier than that with CVSW.

Guided Flat Belt Conveyors – Guided Belt to Prevent Lateral Movement, Center Drive, 3-Groove Frame (Pulley Dia. 50mm)



CVGW 6W Motor Type

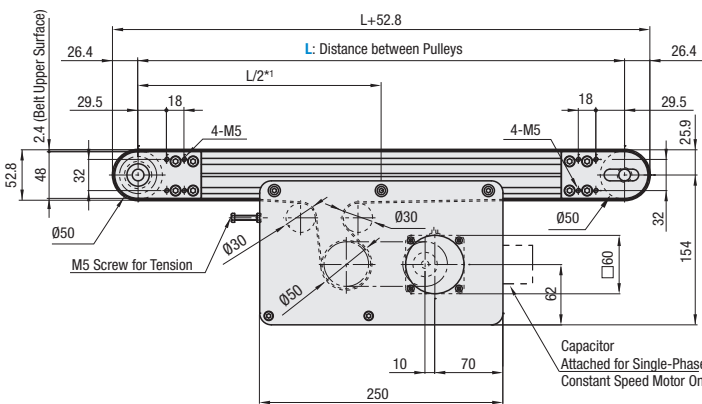
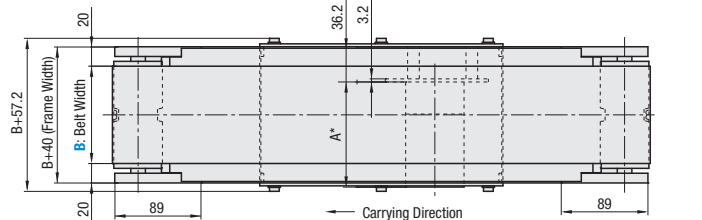

	Frame	Motor Cover (1)	Motor Cover (2)	Pulley Holder
Material	Aluminum	Aluminum	Low Carbon Steel	Aluminum
Surface Treatment	Clear Anodize	Paint	Paint	Paint

Frame Cross Section and Enlarged View (Symmetrical)

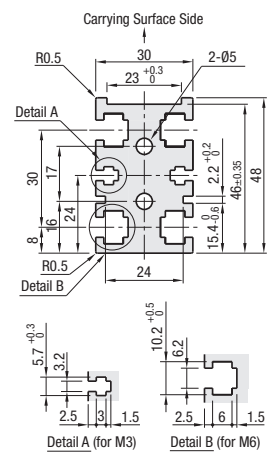

Compatible with JIS standard hex nuts.

25W Motor Type

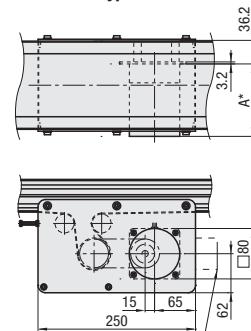

40W Motor Type

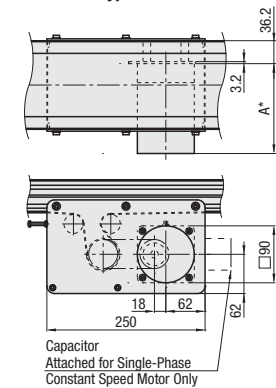

*1 The drive section can be moved to a desired position within the aluminum extrusion slots.
*2 When L=485, each slot has four (4) nuts pre-inserted.
When counterbores for the nuts are required, please specify in alterations.

The dimensions in the diagram are for Belt Specifications H (0.8mm thick). Take note that belt thickness varies by Belt Specifications.

Motor Specifications

Output (W)	Specification	Motor Manufacturer	Reduction Ratio	Motor Length (A)
6W	Constant Speed Motor	Panasonic	12.5-25	101.0
			30-180	108.0
		Oriental	12.5-18	105.0
			25-180	115.0
	Variable Speed Motor	Oriental	12.5-75	114.7
			90-180	120.7
		Taiwanese	12.5-18	115.0
			30-180	125.0
25W	Constant Speed Motor	Panasonic	12.5-75	126.9
			90-180	132.9
		Oriental	5-180	115.0
			5-18	117.0
	Variable Speed Motor	Taiwanese	25-180	127.5
			5-75	129.0
		Oriental	90-180	136.0
			5-18	127.0
40W	Constant Speed Motor	Panasonic	5-180	142.0
			5-18	147.0
		Oriental	25-180	165.0
			5-75	164.6
	Variable Speed Motor	Taiwanese	90-180	173.6
			5-18	157.0
		Oriental	25-180	175.0
			5-75	175.1

Conveying Capacity

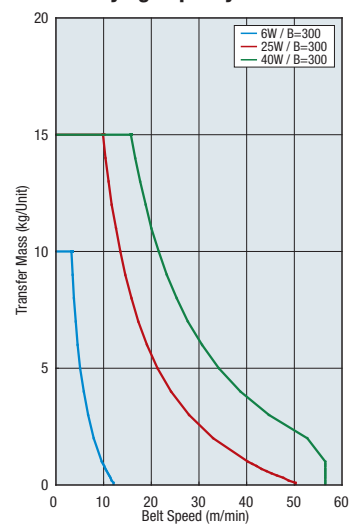

Gearhead Reduction Ratio

*May decrease depending on load condition.

Gearhead Reduction Ratio	Belt Speed (m/min)	
	50Hz	60Hz
5	47.1	56.5
7.5	31.4	37.7
9	26.2	31.4
12.5	18.8	22.6
15	15.7	18.8
18	13.1	15.7
25	9.4	11.3
30	7.9	9.4
36	6.5	7.9
50	4.7	5.7
60	3.9	4.7
75	3.1	3.8
90	2.6	3.1
100	2.4	2.8
120	2.0	2.4
150	1.6	1.9
180	1.3	1.6

Guided Flat Belt Conveyors Guided Belt to Prevent Lateral Movement, Center Drive, 3-Groove Frame (Pulley Dia. 50mm), continued

Conveyor Resource Site:
http://www.misumiusa.com/conveyor/
Conveyor selection, Design your own kit,
& Maintenance parts search.

Part Number	Width B 1mm Increment	Length L 5mm Increment	Motor				Belt Specification	Motor Manufacturer Selection ⓐ The prices vary by manufacturer.
			Output (W)	Voltage (V)	Specification	Gearhead Reduction Ratio		
CVGW	50-300	385-2000	6 25 40	(Single-Phase) TA100 TA110 TA115 TA200 TA220 TA230	IM (Constant Speed Motor) SCM (Variable Speed Motor)	5 7.5 9 12.5 15 18 25 30 36 50 60 75 90 100 120 150 180	H (General Purpose, Green) W (General Purpose, White) G (For Sliding, Green) S (For Sliding, White) D (Static Conductive) O (Oil Resistant) N (Non-Stick Food Grade) J (No Belt)	A (Panasonic Motor) B (Oriental Motor) C (Taiwanese Motor) * SCM (Variable Speed Motor) is not selectable for A.
			25 40	(Three-Phase) SA200 SA220 SA230	IM (Constant Speed Motor)	⊗ 5-9 not applicable for 6W Motor	* For belts other than the above, select from Belt Specification below.	R (No Motor, Gearhead)
			6 25 40	NV (No Motor)	NM (No Motor)	NH (No Gearhead)		

- ⓐ Connect the motor so that the belt rotates in the direction of conveyance.
- ⓑ When "No motor, gearhead" is selected, the motor mounting hole pitch will vary depending on the motor's power rating. Please see Technical Information in our Conveyor Selection web site for the dimension details.
- ⓒ When "No motor, gearhead" is selected, this unit will be delivered unassembled. The customer is to assemble the unit according to the included assembly instructions. See our Conveyor Selection site for assembly procedures and packaging details.
- ⓓ Note that warpage might occur on the guided belt depending on the number of plies (thickness).

Belt Specification	Standard Belt	Optional Belt 1	Optional Belt 2	No Belt
General Purpose	H (Green), W (White)	—	—	J (No Belt)
For Sliding	G (Green), S (White), SN (White)	—	—	
For Inclined Transfer	—	—	—	
Grip Type	—	—	GG (Green), GW (White)	
Oil Resistant	O (Green)	OW (White)	—	
Non-adhesive	N (White)	NB (Sky Blue), NBG (Lime Green) HH (Green), HW (White)	HBG (Green)	
For Food Transfer	—	KW (White), KSB (Sky Blue), PHB (Sky Blue)	—	
Static Conductive	D (Black)	—	—	

ⓓ If using Optional Belts, please select motor manufacturer A or B (Motor C is applicable for Standard Belt only).

Part Number	B	Applicable Sizes																	
		L385-400	L405-500	L505-600	L605-700	L705-800	L805-900	L905-1000	L1005-1100	L1105-1200	L1205-1300	L1305-1400	L1405-1500	L1505-1600	L1605-1700	L1705-1800	L1805-1900	L1905-2000	
CVGW	50-100	•	•	•	•	•	•	•	•	•	•	•	•	•	•	•	•	•	•
	110-150	•	•	•	•	•	•	•	•	•	•	•	•	•	•	•	•	•	•
	160-200	•	•	•	•	•	•	•	•	•	•	•	•	•	•	•	•	•	•
	210-250	•	•	•	•	•	•	•	•	•	•	•	•	•	•	•	•	•	•
	260-300	•	•	•	•	•	•	•	•	•	•	•	•	•	•	•	•	•	•

Part Number Example

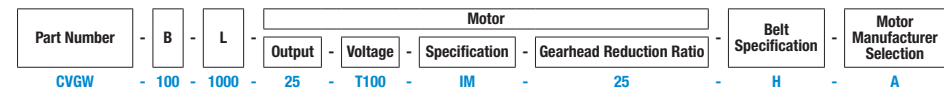

Part Number Alterations

Specify Drive Section Position
Additional Counterbores
Roller Edge
Motor Cover with Window
Brackets for Speed Controller Included
Post-Assembly Insertion Nuts Included
Motors with Electromagnetic Brake
Stands (Legs)

For details of alterations, see P.1276.