

# Stepped Screws / Wing Hinge Screws

Low Head Selectable

**Stepped Screws** RoHS 10

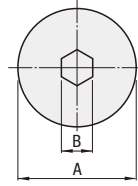



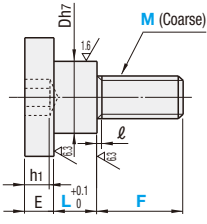

Type	M Material	S Surface Treatment
DBB	1045 Carbon Steel	Black Oxide
DBS	303 Stainless Steel	-

Part Number	Type	M (Coarse)	L	F	E	Dh7	A	B	ℓ	h1	DBB				DBS			
											Unit Price		Volume Discount Rate		Unit Price		Volume Discount Rate	
											1-4 pc(s).	5-19 pcs.	20-49 pcs.	50-99 pcs.	1-4 pc(s).	5-19 pcs.	20-49 pcs.	50-99 pcs.
DBB	DBS	3	3	3 4 5 6	2	5	8	2	1	2								
			4	3 4 5 6														
			5	3 4 5 6														
			6	3 4 5 6														
			7	4 5 6														
			8	4 5 6														
			3	4 5 6 8														
			4	4 5 6 8														
			5	4 5 6 8														
			6	4 5 6 8														
DBB	DBS	4	3	4 5 6 8	2.8	6	10	2.5	1.2	2.5								
			4	4 5 6 8														
			5	4 5 6 8														
			6	4 5 6 8														
			7	4 5 6 8														
			8	5 6 8														
			10	6 8														
			3	5 8 10														
			4	5 8 10														
			5	5 8 10														
DBB	DBS	5	3	5 8 10	3.5	8	12	3	1.4	3								
			4	5 8 10														
			5	5 8 10														
			6	5 8 10														
			7	5 8 10														
			8	5 8 10														
			3	8 10 12														
			4	8 10 12														
			5	8 10 12														
			6	8 10 12														
DBB	DBS	6	3	8 10 12	4	10	16	4	1.5	3.5								
			4	8 10 12														
			5	8 10 12														
			6	8 10 12														
7	8 10 12																	
10	8 10 12																	

For orders larger than indicated quantity, please request a quotation.

**Wing Hinge Screws** RoHS 10



**DNDN**

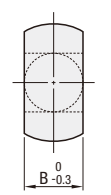

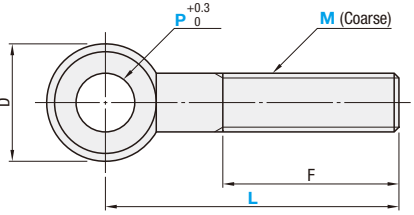

**M** Material: 304 Stainless Steel

Part Number	Type	P	L	D	B	M	F	Unit Price	Volume Discount Rate
		1-9 pc(s).		10-50 pcs.					
DNDN	6	30	12	6	6	22			
		50				30			
		30				20			
	8	50	16	8	8	30			
		60				30			
		50				30			
	10	70	20	10	10	40			
		100				50			
		50				30			
	12	80	24	12	12	45			
		100				60			
		100	32	16	16	50			

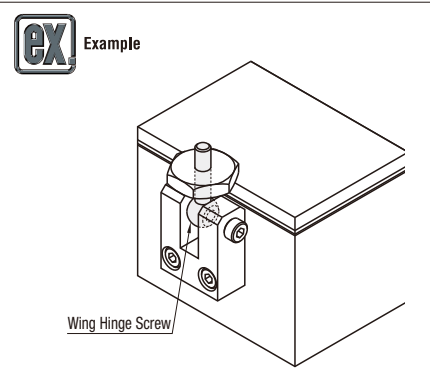

For orders larger than indicated quantity, please request a quotation.

Ordering Example: Part Number - L - F  
DBS6 - 3 - 10  
DNDN6 - 30

Days to Ship [Configure Online](#)

# Stepped Screws

Extra Low Head / Low Head / Button Head Cap Screws / Phillips

**Stepped Screws** RoHS 10



Extra Low Head	Low Head	Button Head Cap Screws	Phillips	M Material	S Surface Treatment
DBGB	DBTB	DBBB	DBJB	1045 Carbon Steel	Black Oxide
DBGM	DBTM	DBBM	DBJM	1045 Carbon Steel	Electroless Nickel Plating
DBGS	DBTS	DBBS	DBJS	303 Stainless Steel	-

• Extra Low Head

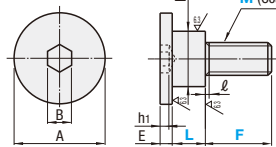

• Low Head

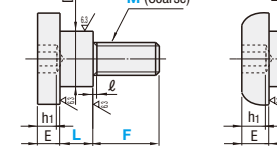

• Button Head Cap

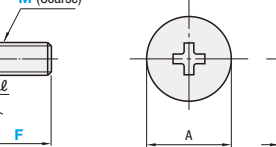

• Phillips

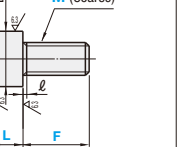

**Extra Low Head**

Part Number	Type	M (Coarse)	1mm Increment		E	D	A	B	ℓ	h1	Unit Price				
			L	F							DBGB	DBGM	DBGS		
DBGB DBGM DBGS		3	5-20	3-6	1.5	5	8	1.5	1	1.5					
				4-8											
				5-10											
				6-12											
				8-12											
				10-15											
				6							1.5	8-12			
				8								10-15			
				10											
				12											

**Low Head**

Part Number	Type	M (Coarse)	1mm Increment		E	D	A	B	ℓ	h1	Unit Price					
			L	F							DBTB	DBTM	DBTS			
DBTB DBTM DBTS		3	3-20	3-6	1.5	2	5	8	2	1	2					
				4-8												
				5-10												
				6-12												
				8-12												
				10-15												
				4								1.5	8-12			
				6									10-15			
				8												
				10												

**Button Head Cap Screws**

Part Number	Type	M (Coarse)	1mm Increment		E	D	A	B	ℓ	h1	Unit Price					
			L	F							DBBB	DBBM	DBBS			
DBBB DBBM DBBS		3	5-20	3-6	1.5	2.8	5	8	2	1	2					
				4-8												
				5-10												
				6-12												
				8-12												
				10-15												
				4								1.5	8-12			
				6									10-15			
				8												
				10												

**Phillips**

Part Number	Type	M (Coarse)	1mm Increment		E	D	A	ℓ	Unit Price						
			L	F					DBJB	DBJM	DBJS				
DBJB DBJM DBJS		3	1-20	3-6	1.5	2.8	5	8	1	1.2					
				4-8											
				5-10											
				6-12											
				8-12											
				10-15											
				4							1.5	8-12			
				6								10-15			
				8											
				10											

Ordering Example: Part Number - L - F  
DBTS6 - 3 - 10

Alterations: Part Number - L - F - (LTC, PC)  
DBJM6 - 3.4 - 10 - LTC

Days to Ship [Configure Online](#)

Price [Configure Online](#)

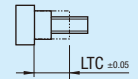
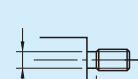
Alterations	Code	Spec.	Price Adder																												
	LTC	L Dimension Increment LTC=0.1mm Increment																													
	PC	Adds a relief on M. <table border="1"> <thead> <tr> <th>D</th> <th>M x Pitch</th> <th>g</th> <th>f</th> </tr> </thead> <tbody> <tr> <td>5</td> <td>M3 x 0.5</td> <td>1</td> <td>2.3</td> </tr> <tr> <td>6</td> <td>M4 x 0.7</td> <td>1.2</td> <td>3.2</td> </tr> <tr> <td>8</td> <td>M5 x 0.8</td> <td>1.4</td> <td>4.0</td> </tr> <tr> <td>10</td> <td>M6 x 1.0</td> <td>1.7</td> <td>4.8</td> </tr> <tr> <td>12</td> <td>M8 x 1.25</td> <td>1.7</td> <td>6.5</td> </tr> <tr> <td>15</td> <td>M10 x 1.5</td> <td>2</td> <td>8.2</td> </tr> </tbody> </table>	D	M x Pitch	g	f	5	M3 x 0.5	1	2.3	6	M4 x 0.7	1.2	3.2	8	M5 x 0.8	1.4	4.0	10	M6 x 1.0	1.7	4.8	12	M8 x 1.25	1.7	6.5	15	M10 x 1.5	2	8.2	
D	M x Pitch	g	f																												
5	M3 x 0.5	1	2.3																												
6	M4 x 0.7	1.2	3.2																												
8	M5 x 0.8	1.4	4.0																												
10	M6 x 1.0	1.7	4.8																												
12	M8 x 1.25	1.7	6.5																												
15	M10 x 1.5	2	8.2																												